



# LOCALE

MAGAZINE

*Living like a local*

MEDIA KIT 2025

[localemagazine.com.au](http://localemagazine.com.au)

## Living like a local

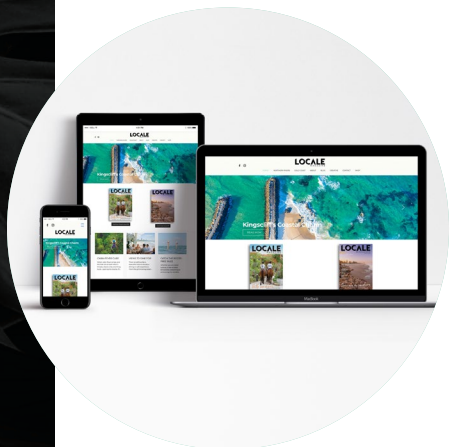

- Locale Magazine is dedicated to promoting businesses and attractions in the Northern Rivers region and includes Gold Coast region.
- Our premier 84-page quarterly magazines cover local fashion, dining, living, arts, entertainment, lifestyle, and beauty.
- Our team of creative locals is passionate about highlighting the wonderful aspects of these regions and communities.
- We distribute 10,000 printed copies throughout the Northern Rivers and the Gold Coast in various establishments such as resorts, Airbnbs, hotels, cafes, restaurants, and fashion boutiques.
- Multiple booking discounts are available to help businesses maximize their exposure.
- In addition to our print editions, Locale Magazine has a rapidly growing online presence.
- When you advertise with us, your business receives dedicated social media posts across our platforms, including Instagram.
- Our social media profiles drive traffic to our website and promote our advertisers, events, and services.



### SALES AND ADVERTISING ENQUIRIES

[sales@localemagazine.com.au](mailto:sales@localemagazine.com.au)

### EDITORIAL ENQUIRIES

[editor@localemagazine.com.au](mailto:editor@localemagazine.com.au)

# STATS



FREQUENCY  
QUARTERLY



PRINT COPIES  
10,000



DEMOGRAPHIC  
25-70YOs



LOCATION  
NORTHERN RIVERS  
GOLD COAST



EMAIL  
SUBSCRIBERS  
5,000+



ONLINE  
READERSHIP  
7,000+



SOCIAL MEDIA  
7,000+



DISTRIBUTION  
NORTHERN RIVERS  
GOLD COAST



MAGAZINE PAID  
SUBSCRIBERS  
250+



ONLINE READS  
PER MONTH  
3100+



AVERAGE  
TIME READ  
26min



DWELL TIME  
PER ARTICLE  
1:54min

# REGULAR SECTIONS AND FEATURES

---

## FEATURES

Our **Features** section dives deep into the stories that shape the Northern Rivers region. From inspirational local personalities to impactful community initiatives, we highlight the movers and shakers who are making a difference. Each feature offers a thoughtful narrative, exploring diverse topics from environmental conservation to cultural trends, ensuring our readers stay connected with the region's heartbeat.

---

## DISCOVER

**Discover** introduces readers to hidden gems and must-visit spots across Northern Rivers. Whether it's a scenic lookout, a boutique shopping experience, or a tucked-away café, this section is dedicated to showcasing local treasures. Readers can explore new places and experiences, all curated with insider knowledge for those who want to truly live like a local.

---

## DINE

Food lovers will revel in our **Dine** section, where we spotlight the region's vibrant culinary scene. From farm-to-table restaurants to buzzing beachfront cafes, we celebrate the passion behind each dish and the talented chefs who bring it to life. Our reviews, profiles, and dining guides help readers discover where to eat, drink, and enjoy local flavors.

---

## LIFESTYLE

Our **Lifestyle** section offers insights into the Northern Rivers way of life. Covering everything from wellness and fitness to home décor and fashion, we embrace the laid-back, health-conscious ethos that defines the area. Readers can find inspiration to enhance their daily routines with a touch of local flair.

---

## ESCAPE

The **Escape** section transports readers to serene getaways and adventure-filled destinations within and beyond the Northern Rivers. Whether it's a luxurious beachside retreat or a weekend camping trip in the hinterland, we provide readers with inspiration for their next travel experience, encouraging them to unplug and recharge.

---

## THE ARTS

In **The Arts**, we showcase the region's thriving creative community. This section celebrates artists, musicians, galleries, and cultural events, giving readers an inside look into the artistic pulse of Northern Rivers. From up-and-coming talent to established creatives, we cover the diverse art forms and cultural happenings that make the area a vibrant hub for creativity.

# DEADLINES 2025

EDITION	BOOKING DEADLINES	MATERIAL DEADLINE	DISTRIBUTION
SUMMER '24/25	4th November	18th November	1st December
AUTUMN '25	7th February	14th February	14th March
WINTER '25	9th May	16th May	13th June
SPRING '25	8th August	15th August	12th September
SUMMER '25/26	7th November	14th November	12th December

## ARTWORK

- Print artwork to be supplied as Press Ready PDF, using CMYK colours
- Images must be minimum 300dpi
- Complete material supplied as press quality pdf (300 dpi)
- Photography, copy writing, design and layout fees on application
- Proof supplied in PDF format, changes and approvals required by email
- Advertisers are responsible for accuracy on proofing.

## Design support

Need help with your artwork? We have a full design service to help develop your advertisement for an additional fee. Always here to help locals!

# ADVERTISING RATES

## RATES PER QUARTER

15% PREMIUM POSITION LOADING FEES APPLY. 10% GST APPLIES ON ALL PRICES

AD SIZE	CASUAL per quarter
Full page	\$1,850
Half page	\$980
Quarter Page	\$620
Inside FC / BC	\$2,280
DPS	\$2,990
Back cover	\$2,800
Front Cover	\$4500 (includes double page editorial value \$2300)
Double page advertorial	(upto 800 words upto 5 images) \$2,300
Full page advertorial	(upto 500 words upto 3 images) \$1,400
1/2 page advertorial + Half page advert	(300 words + 1 image) \$1580
Editorial inclusion	(150 words + 1 Image) \$250
Product Placement	\$200/product

## DIGITAL ADVERTISING RATES

Banner advert in e-newsletter	\$450/quarter
Blog post on our website	\$2/word

**PAYMENT & CANCELLATION TERMS:** Total cost per issue to be paid as follows: On contract, full payment. · With proof approval, full payment total cost. · Cancellations after the booking deadline will be charged at full rate. · Written cancellations accepted seven days prior to booking deadline.

# PAGE SPECS

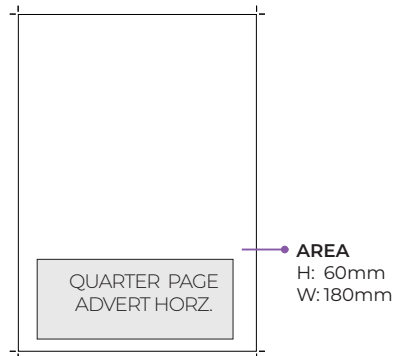
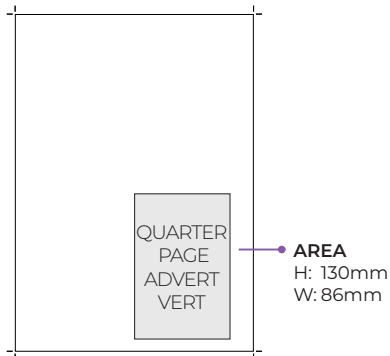
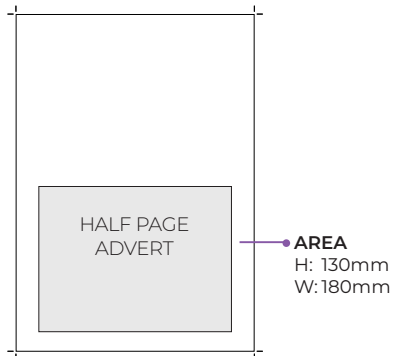
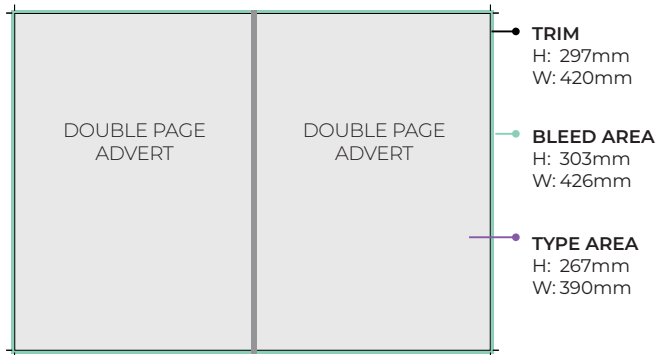
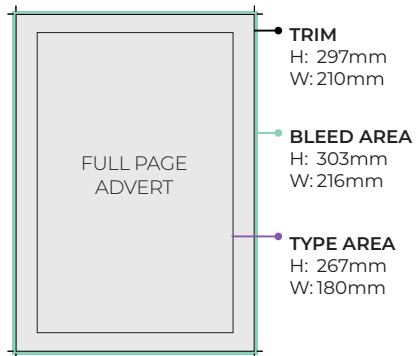



100% VEGAN — #BRUSSELSNOTBEEF

**NO BONES**

11 FLETCHER STREET, BYRON BAY | 83 MAJAH ROAD, OCEAN SHORES

@NOBONESRESTAURANTS  
WWW.NOBONESRESTAURANTS.COM.AU

FULL PAGE ADVERT

**Blue Office**  
Hydrogen Day

A good coffee changes everything...  
Roasting here in Byron Bay

Monday Friday 6am - 3pm  
Saturday 7am - 12am

QUARTER PAGE ADVERT

**RE/WIND**

RE/WIND brings you an experience like no other. Equipped with a built-in day chair, yoga mat and everything from hairbrush, to yoga blocks, to locally sourced and sustainably sourced.

11 Cambridge Ave. | Ocean View VIC  
Melbourne | Sydney | Perth | Brisbane | Gold Coast | Adelaide | Hobart | Darwin

HALF PAGE ADVERT

**SIPPING IN THE SUNSHINE**

ROASTED BY ALEX WILSON

Cafe culture is strong in this city. Gold Coast's take on coffee culture is unique, and our local baristas struggle to keep up with the rising costs of the most essential ingredients: from beans, plants and all things to healthy, boutique blends and brews made from locally grown beans, here's a guide to the best coffee in town.

**Blue Bakery** - **Instagram**  
Brisbane's oldest cafe and a Melbourne City Star Bakery, Blue Bakery is a cafe and bakery in Brisbane's CBD. The cafe is known for its specialty coffee, pastries, and breads. It's a great spot for a quick bite or a sit-down meal.

**Blue Coffee** - **Instagram**  
Blue Coffee is a specialty coffee roaster in Brisbane. They offer a range of single-origin and blended coffees, as well as a variety of coffee beans for sale.

**Blue Coffee** - **Instagram**  
Blue Coffee is a specialty coffee roaster in Brisbane. They offer a range of single-origin and blended coffees, as well as a variety of coffee beans for sale.

EDITORIAL INCLUSION

**LOCALE must-have!**

The items are changing and it's time to refresh and revitalize, and our new range of the 'Must-Have' collection.

**WALKER FIVE FIVE**  
Walker Five Five is a range of products that are perfect for the office or home. It includes a range of pens, pencils, and notebooks.

**WALKER FIVE FIVE**  
Walker Five Five is a range of products that are perfect for the office or home. It includes a range of pens, pencils, and notebooks.

**WALKER FIVE FIVE**  
Walker Five Five is a range of products that are perfect for the office or home. It includes a range of pens, pencils, and notebooks.

PRODUCT PLACEMENT

**MEETING MUKTI - THE FOUNDER AND NAMESAKE OF MUKTI ORGANICS**

Meet Mukti, the founder and namesake of Mukti Organics. She is a passionate advocate for natural beauty and wellness. Her products are made from natural ingredients and are free from harsh chemicals.

**MUKTI BEAUTY MOODS AND PLEASURES RETAIL STORE**  
Our retail store is located in Byron Bay. It offers a range of natural beauty products, including skincare, haircare, and bodycare. The store is a great place to explore the Mukti Organics range.

**Specials & Offers**  
We have a range of special offers and discounts available. Check out our website for more details.

**Body & Soul**  
1300 394 574  
Mukti Organics  
Mukti Organics

HALF PAGE ADVERTORIAL & ADVERT

**CHANGING LIVES BY Changing Skin**

Young skin that's not as resilient as it once was? It's not just a matter of time. It's a matter of skin care. The right skin care can help you keep your skin looking young and healthy for years to come.

**Chang Skin**  
Chang Skin is a range of skincare products that are designed to help you keep your skin looking young and healthy. It includes a range of cleansers, toners, and moisturizers.

**Chang Skin**  
Chang Skin is a range of skincare products that are designed to help you keep your skin looking young and healthy. It includes a range of cleansers, toners, and moisturizers.

FULL PAGE ADVERTORIAL

**KIRRA CALLING BEACH BLISS MEETS CULINARY DELIGHTS**

When you're looking for a place to relax and unwind, Kirra Calling is the perfect spot. It's a beautiful beachside cafe and restaurant that offers a range of delicious food and drinks. The outdoor seating area is perfect for enjoying the view and the fresh air.

**Kirra Calling**  
Kirra Calling is a beachside cafe and restaurant that offers a range of delicious food and drinks. The outdoor seating area is perfect for enjoying the view and the fresh air.

**Kirra Calling**  
Kirra Calling is a beachside cafe and restaurant that offers a range of delicious food and drinks. The outdoor seating area is perfect for enjoying the view and the fresh air.

DOUBLE PAGE ADVERTORIAL





**LOCALE**  
MAGAZINE

*Living like a local*

**FOLLOW US**

 [locale\\_magazine](https://www.instagram.com/locale_magazine)

 [localemagazineau](https://www.facebook.com/localemagazineau)

[localemagazine.com.au](http://localemagazine.com.au)